

Mouting direction

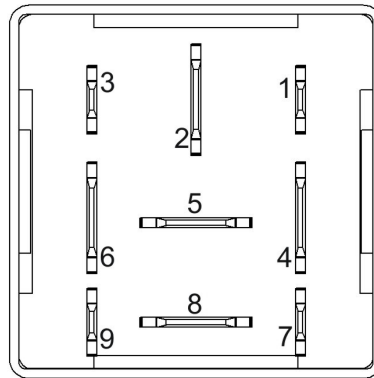

View of plug

## DESCRIPTION

The Micro PLC CAN is a small control system for automotive applications. Free configuration and programmability offer a wide range of applications in the automotive sector. Control and readout are done via the CAN bus (ISO 11898-2). Freescale Processor with Flash technology (option of multiple programming).

## TECHNICAL DATA

Housing	Plastic PA66GF30
Connector	Base plate 9-pin
Weight	31 g
Ambient temperature (according to ISO 16750-4)	-40°C to +85 °C (at +85 °C not full load)
Environmental Protection	IP 53
Current consumption	27 mA
Protection	Depending on the variety of available configurations: cf. p. 7/8
Total inputs and outputs	Depending on the variety of available configurations: See p. <a href="#">7/8</a>
Inputs	<b>Configurable as:</b> Analogue input (0 ... 11,4 V) Digital, positive encoder signal frequency input
Outputs	<b>Configurable as:</b> Digital, positive switching (high-side or relay output) PWM output (3 Hz ... 500 Hz)
Operating voltage	Depending on the variety of available configurations: 12 V (Code C) and 24 V (Code F) ISO 16750 – 2 compliant
Starting voltage	8,5 V (12 V variant) 16 V (24 V variant)
Overvoltage protection	≥ 33 V
Undervoltage cut-off	8,5 V
Quiescent current	Depending on the variety of available configurations: See p. <a href="#">7/8</a>
Reverse polarity protection	Yes
CAN Interfaces	CAN bus interface 2.0 A/B, ISO 11898-2:2003 compliant

## REGULATORY APPROVALS AND TESTINGS

E1 Approval	ECE R10 05 7362 (for variants with VNQ5050)
e1 approval	03 6211 (Relay and BTS442)
Electrical tests	According to ISO 16750 – 2 or -4: Short circuit protection Jump-start (12 V variants) Reverse polarity test Interruption pin und plug Long-term overvoltage at T <sub>Max</sub> -20 °C Storage test at T <sub>Max</sub> and T <sub>Min</sub> Operation test at T <sub>Max</sub> und T <sub>Min</sub> Overlaying AC voltage Low sink and rise of supply voltage Voltage drop Reset behaviour at voltage drop According to ISO 7637 - 2: Puls 1, 2a, 2b, 3a, 3b

## SOFTWARE/PROGRAMMING

Programming System

### MRS Developers Studio

MRS Developers Studio with built-in functions library, similar programming with FUP. Custom software blocks can be integrated into "C-code". Program memory is sufficient for about 300 basic logic components.

INPUT FEATURES - SUMMARY

<b>Pin X (1)</b>			<b>Pin 15 (4)<sup>2</sup></b>		
Usable as analog or digital input			Usable as analog or digital input		
Resolution			Resolution		
Accuracy			Accuracy		
12 Bit ± 1% full scale			12 Bit ± 1% full scale		
Voltage input 0...11.4 V (see <a href="#">A</a> )	Input resistance	22,6 kΩ	Voltage input 0...11.4 V (see <a href="#">A</a> )	Input resistance	21,4 kΩ
	Input frequency	fg <sup>1</sup> = 60 Hz		Input frequency	fg <sup>1</sup> = 65 Hz
	Accuracy	± 2 %		Accuracy	± 10 %
Digital input positiv (see <a href="#">C</a> )	Input resistance	22,6 kΩ	Voltage input 0...33.6 V (see <a href="#">features</a> )	Input resistance	65 kΩ
	Input frequency	fg <sup>1</sup> = 60 Hz		Input frequency	fg <sup>1</sup> = 46 Hz
	Turn-on threshold	6,5 V		Accuracy	± 10 %
	Turn-off threshold	5 V	Digital input positiv (see <a href="#">C</a> )	Input resistance	21,4 kΩ
Frequency input (see <a href="#">B</a> )	Input resistance	22,6 kΩ		Input frequency	fg <sup>1</sup> = 65 Hz
	Input frequency	bis ≤ 2.2 kHz		Turn-on threshold	6,7 V
	Turn-on threshold	6,5 V		Turn-off threshold	6,6 V
	Turn-off threshold	5 V	<b>Pin C (3)</b>		
Usable as analog or digital input			Usable as analog or digital input		
Resolution			Resolution		
Accuracy			Accuracy		
12 Bit ± 1% full scale			12 Bit ± 1% full scale		
only assembly variant S21/S22			Voltage input 0...11.4 V (see <a href="#">A</a> )	Input resistance	21,4 kΩ
				Input frequency	fg <sup>1</sup> = 65 Hz
				Accuracy	± 2 %
			Digital input positiv (see <a href="#">C</a> )	Input resistance	21,4 kΩ
				Input frequency	fg <sup>1</sup> = 65 Hz
				Turn-on threshold	6,5 V
				Turn-off threshold	5 V

<sup>1</sup> cutoff frequency (-3 dB)

OUTPUT FEATURES - SUMMARY

<b>Pin 87, 87A</b>			<b>Pin 87, 87A</b>	
<b>Relais variant</b>			<b>Highside-Treiber Variante</b>	<b>VNQ5050</b>
Load current (Relay, see <a href="#">D</a> )	NO (normally open)	15 A	Wire fault diagnostics	Possible via current sense
	NC (normally closed)	10 A	Short circuit diagnostics	Possible via current sense
	Protection	15 A	Digital, positive switching (High-Side; see <a href="#">E</a> )	Switching voltage
				Switching current
				9-32 V DC
				<a href="#">see performance test</a>
Digital output (open collector output)	max. power	2 W <sup>3</sup>	Current feedback	(ANA_I_OUT_87A ANA_I_OUT_87)
	suppressor circuit against inductive loading	Non existent must be externally fused (free wheel diode)	Protection	Load-dependent

<sup>2</sup> For variants with quiescent current and activated DO\_POWER or CAN INH, the values may differ.

<sup>3</sup> When using an LED, it glows due to the leakage current even when switched off.

CONTINUOUS OUTPUT TEST HIGH-SIDE DRIVER VNQ5050 AT  $T_{MAX} = 85\text{ °C S21}$

Measurement No.	87	87a	Total current	Pass
1	2,5 A	2,5 A	5 A	yes
2	3,5 A	3,5 A	7 A	yes
3	4 A	4 A	8 A	yes
4	4,5 A	4,5 A	9 A	yes
5	3 A	5 A	8 A	yes
6	6 A	2 A	8 A	yes
7	5 A	5 A	10 A	no, not suitable for long term

PIN ASSIGNMENT SUPPLY VOLTAGE AND INTERFACES

Pin	Pin Description	Pin	Pin Description
2	supply voltage	6	Mass/GND
4	Battery/ignition contact 15 according to DIN 72552/ analog-digital input	7	CAN-Bus High
		9	CAN-Bus Low

PIN ASSIGNMENT IN- AND OUTPUTS

Pin	Programm signal	Pin Description	Pin	Programm signal	Pin Description
1	ANA_X D_ANA_X	Analog/ digital input X 0-11,4 V or Frequency input (configuration variant)	4	ANA_15 D_ANA_15	Analog/ digital input 15 0-11.4V
3	ANA_C D_ANA_C C	Analog/ digital input C 0-11,4 V or Digital output C (max 2W)	5	OUT87A  ANA_I_OUT_87A	NC output relays or HSD with configuration variant VNQ5050: Current feedback
			8	OUT87  ANA_I_OUT_87	NO output relays or HSD with configuration variant VNQ5050: Current feedback

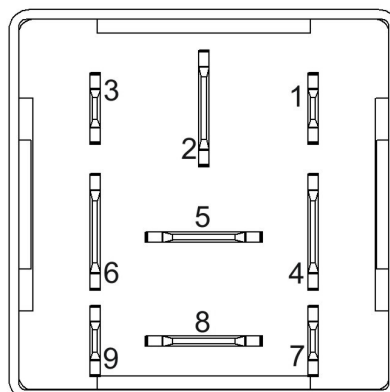

Pin assignment, bottom view

CONNECTION DIAGRAM

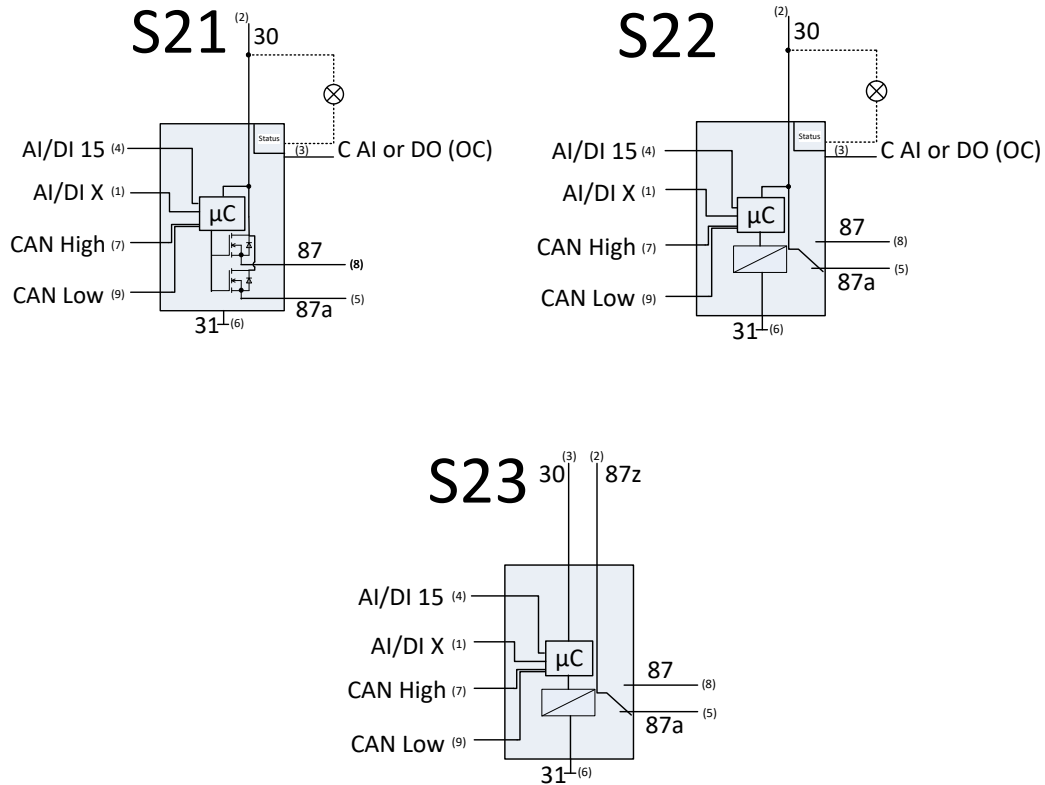

PIN - FEATURE MAP

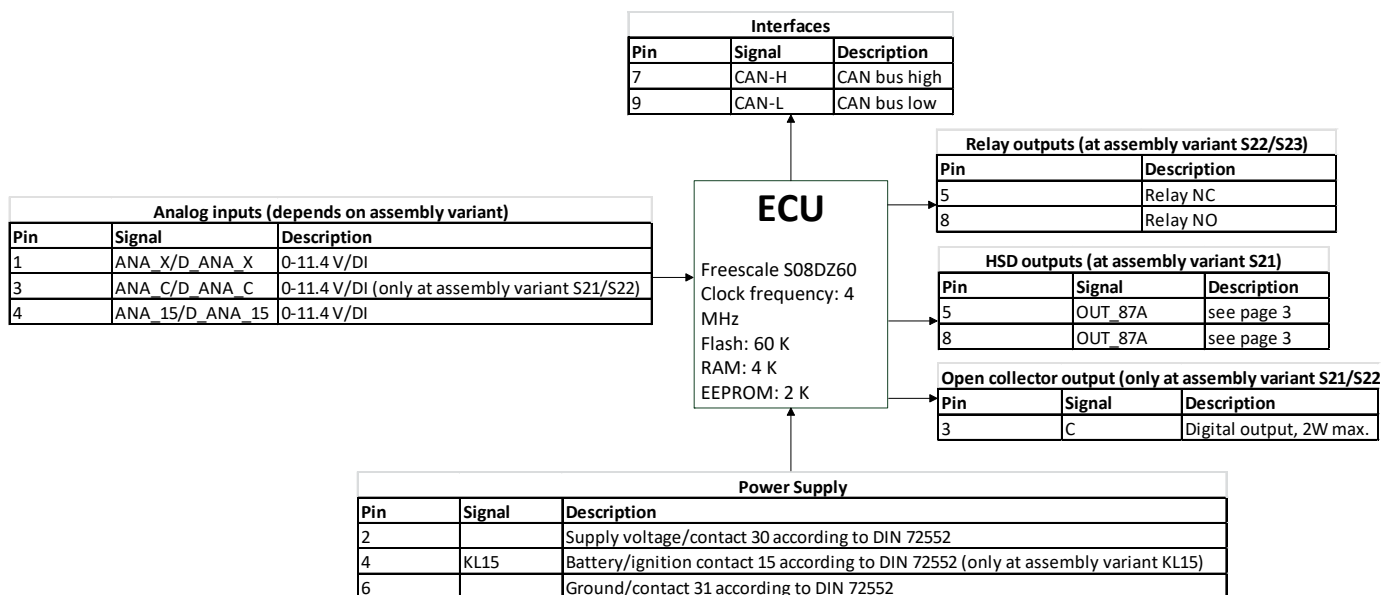

BLOCK FUNCTION DIAGRAM S21/S22

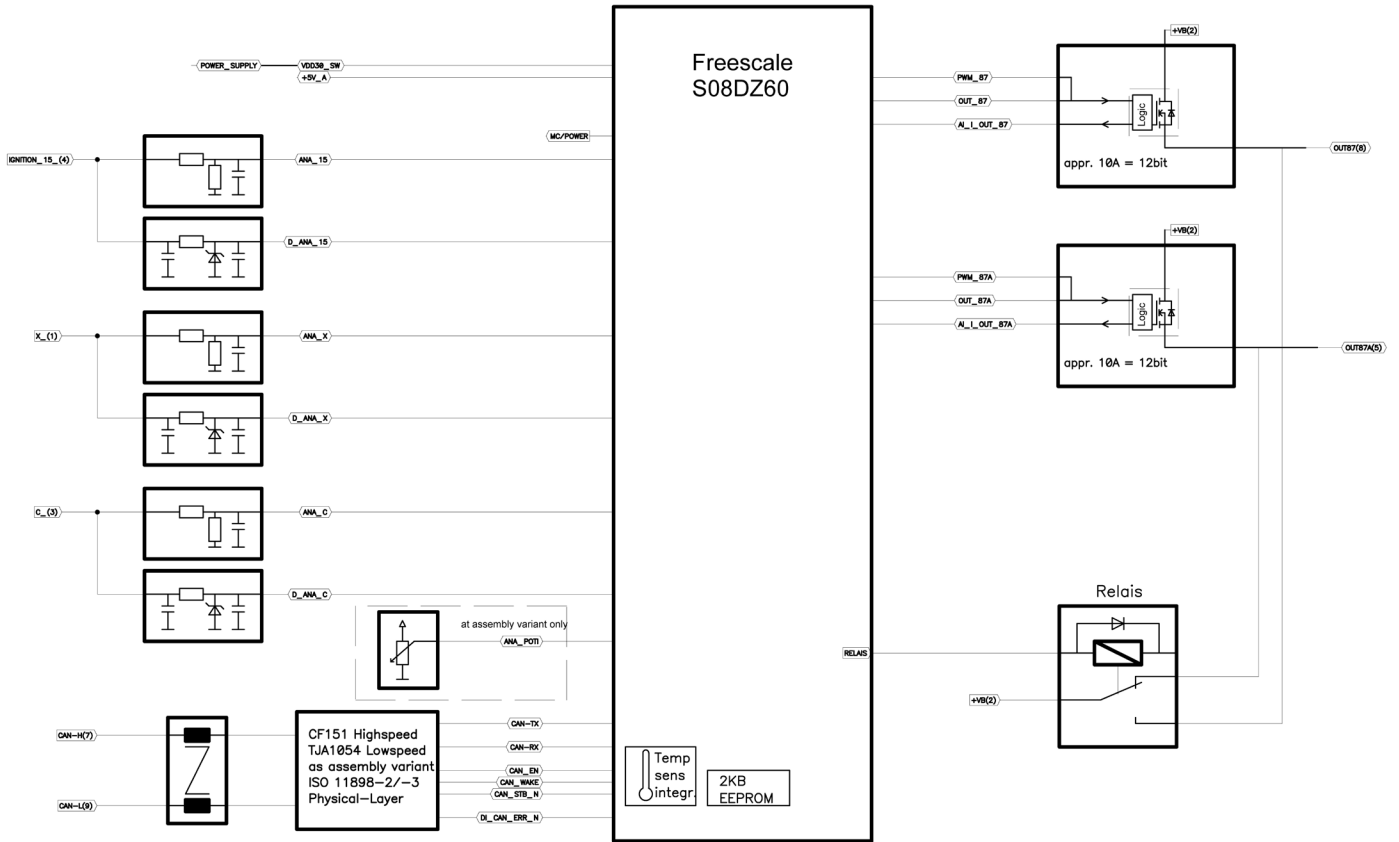

BLOCK FUNCTION DIAGRAM S23

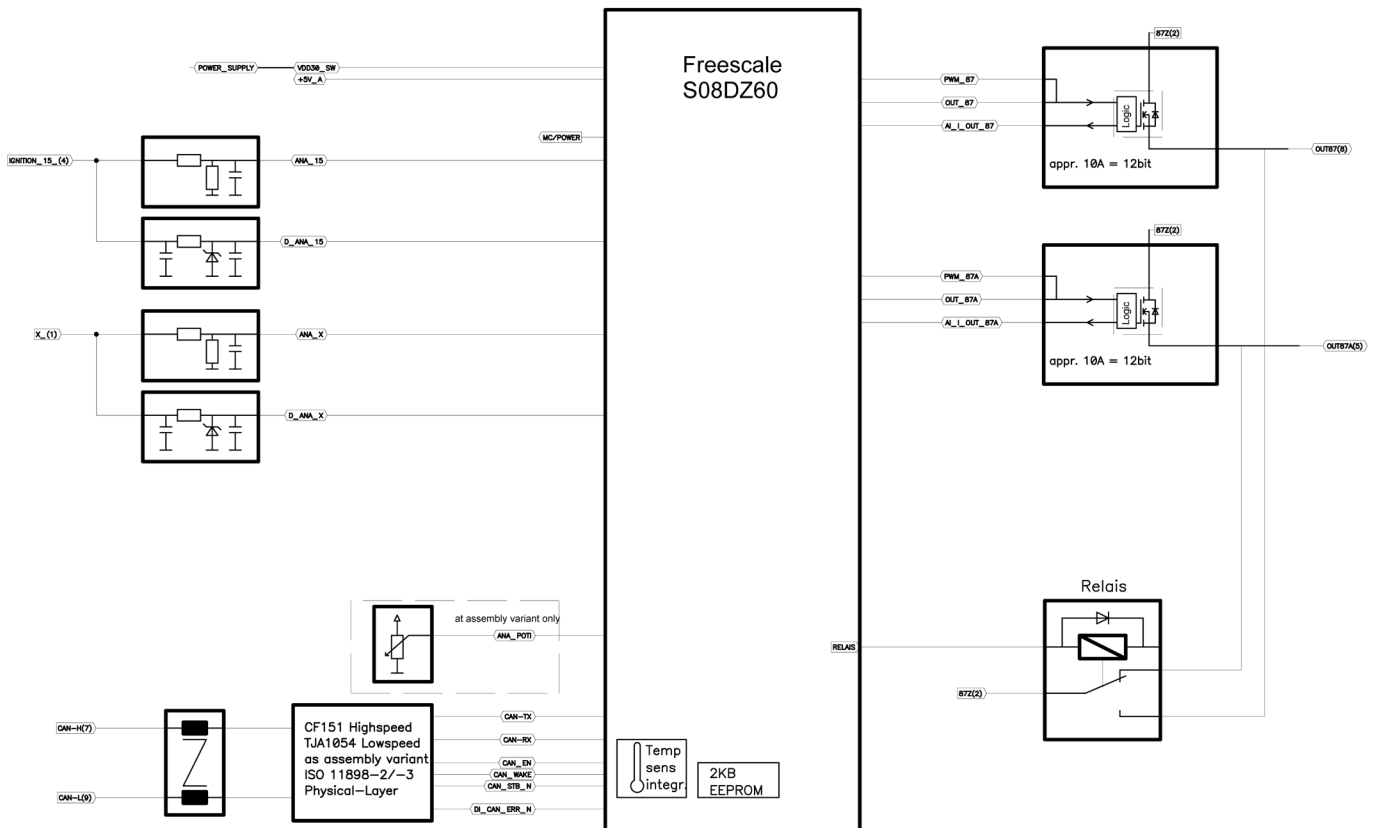

SUPPLY VOLTAGE FOR VARIANT S21/S22

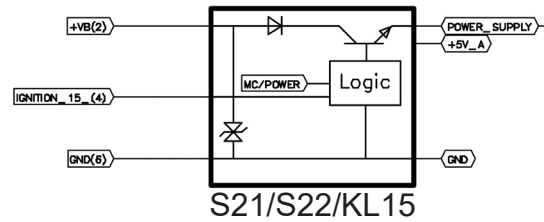
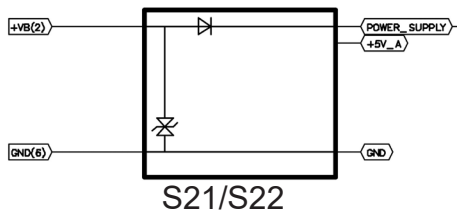

SUPPLY VOLTAGE FOR VARIANT S23

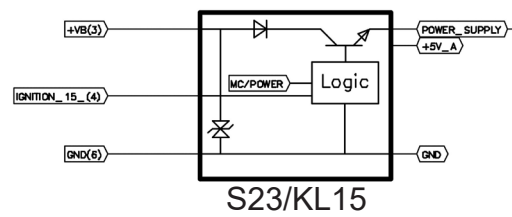
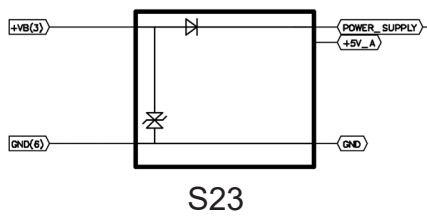

TECHNICAL DRAWING IN MM [IN INCH]

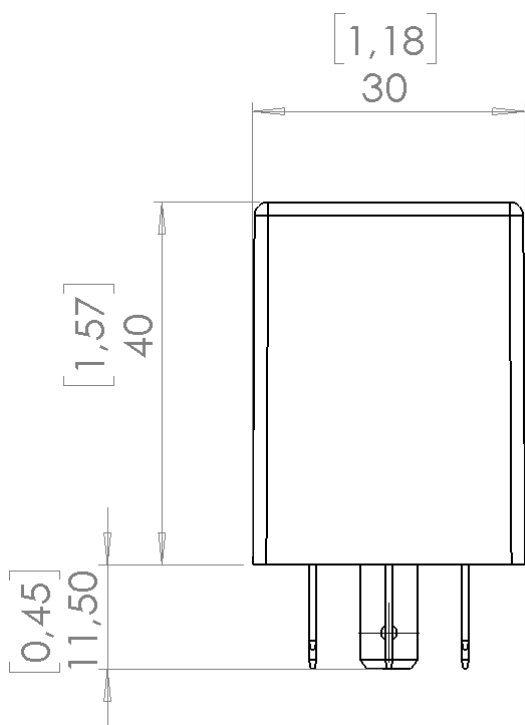

Side view

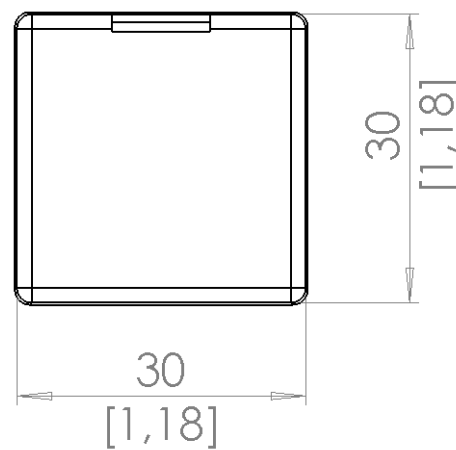

Top-down view

## ASSEMBLY VARIANTS AND ORDERING INFORMATION WITH RELAY OUTPUT

Order number	Supply voltage	Quiescent current 12 V	Quiescent current 24 V	Current consumption 12 V	Current consumption 24 V	Pin numbering of inputs			Pin numbering of outputs	CAN Bus	Features
						A Voltage 0 – 11.4 V	B Frequency Hz	C Digital input			
	see Page 4 or 6	Data in $\mu$ A	Data in $\mu$ A	Data in mA $\pm$ 2 mA	Data in mA $\pm$ 2 mA				D Relay output	High-Speed	
<b>1.107.110.00</b>	12 V/S22	-	-	27	-	1,3,4		1,3,4	5,8	X	
<b>1.107.110.01</b>	12 V/S22	-	-	27	-	3,4	1	1,3,4	5,8	X	
<b>1.107.110.03</b>	12 V/S22	-	-	27	-	3,4	1	1,3,4	5,8	X	with potentiometer
<b>1.107.110.0A</b>	12 V/S22	-	-	27	-	3,4	1	1,3,4	5,8	X	Pin 4: 0-33,6 V
<b>1.107.112.00</b>	12 V/S23	-	-	27	-	1,4		1,4	5,8 (potential-free)	X	
<b>1.107.114.00</b>	12 V/S23/ KL15	1063	-	27	-	1		1	5,8 (potential-free)	X	KL15 for voltage monitoring up to 11.4 V usable
<b>1.107.114.09</b>	12 V/S23/ KL15	259	-	27	-	1		1	5,8 (potential-free)	X	KL15 for voltage monitoring up to 11.4 V usable
<b>1.107.210.00</b>	24 V/S22	-	-	-	27	1,3,4		1,3,4	5,8	X	
<b>1.107.211.08</b>	24 V/S22/ KL15	N/A		-	27	1	3	1,3	5,8	X	KL15 for voltage monitoring up to 11.4 V usable
<b>1.107.212.00</b>	24 V/S23	-	-	-	27,2	1,4		1,4	5,8 (potential-free)	X	
<b>1.107.212.01</b>	24 V/S23	-	-	-	26,1	4	1	1,4	5,8 (potential-free)	X	
<b>1.107.212.04</b>	24 V/S23	-	-	-	37,6	1,4		1,4	5,8 (potential-free)	X	120 $\Omega$ CAN-Bus terminating resistor integrated

## ASSEMBLY VARIANTS AND ORDERING INFORMATION WITH HIGH-SIDE OUTPUT

Order number	Supply voltage	quies- cent curent 12 V	quies- cent curent 24 V	current consump- tion 12 V	current consump- tion 24 V	Pin numbering of inputs			Pin numbering of outputs		CAN Bus	Features
						A Voltage 0 – 11.4 V	B Frequency Hz	C Digital input	E High-Side output	F PWM ≤ 500 Hz		
	see page 4 or 6	Data in µA ± 10 µA	Data in µA ± 10 µA	Data in mA ± 2 mA	Data in mA ± 2 mA						High-Speed	
<b>1.107.310.001</b>	9-32 V/S21	-	-	23	24	1,3,4		1,3,4	5,8	5,8	X	
<b>1.107.310.061</b>	9-32 V/S21	-	-	23	24	3,4	1,4	1,3,4	5,8	5,8	X	
<b>1.107.310.071</b>	9-32 V/S21	-	-	23	24	3,4	1	1,3,4	5,8	5,8	X	Frequency input with 5 V amplitude
<b>1.107.311.001</b>	9-32 V/ S21/KL15	250	400	23	24	1,3		1,3	5,8	5,8	X	KL15 for voltage monitoring up to 11.4 V usable
<b>1.107P.310.001</b>	9-32 V/S21	-	-	23	24	1,3,4		1,3,4	5,8	5,8	X	CANopen



## ACCESSORIES

Name	Order number
Starter-Kit $\mu$ SPS CAN	1.100.110.22
Softwaretool MRS Developer Studio	1.100.100.09
PCAN-USB Interface	105358
Cable sets to program	109446
Sockets	1.017.002.00
Tab receptacle 6,3 mm/1,5-2,5 mm <sup>2</sup>	103064
Tab receptacle 2,8 mm/0,5-1,0 mm <sup>2</sup>	105292



## MANUFACTURER

MRS Electronic GmbH & Co. KG  
 Klaus-Gutsch-Str. 7  
 78628 Rottweil

NOTES ON WIRING AND CABLE ROUTING

Hightside outputs may only be switched to ground.

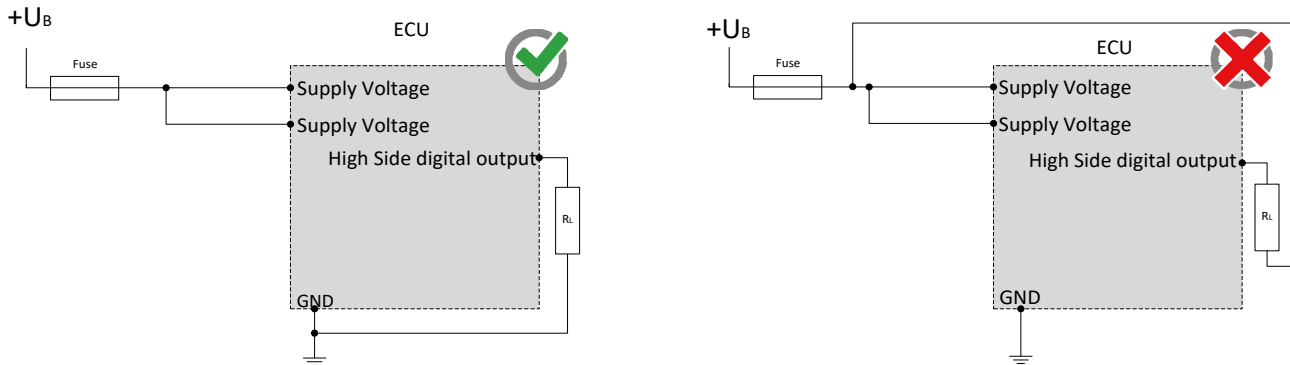

CAN bus communication is the main communication between the control unit and the vehicle. Therefore, connect the CAN bus with special care and check the correct communication with the vehicle to avoid undesired behavior.

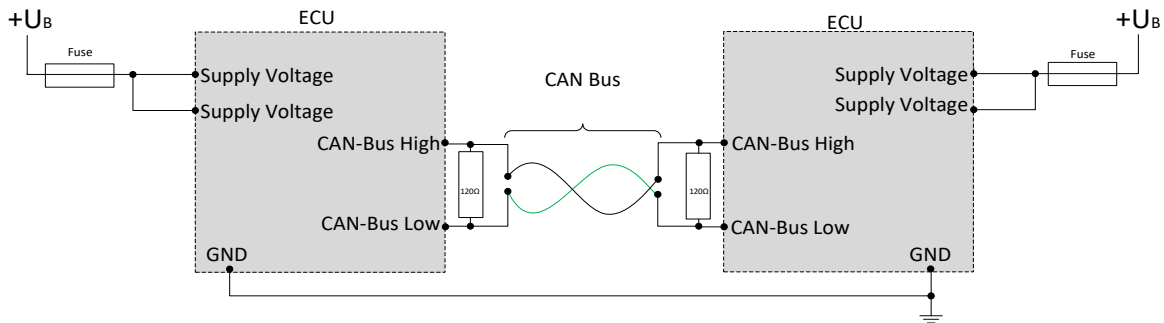

## SAFETY AND INSTALLATION INFORMATION

It is essential to read the instructions in full thoroughly before working with the device.

Please note and comply with the instructions in the operating instructions and the information in the device data sheet, see [www.mrs-electronic.com](http://www.mrs-electronic.com)

**Staff qualification:** Only staff with the appropriate qualifications may work on this device or in its proximity.

### SAFETY



**WARNING! Danger as a result of a malfunction of the entire system.**

Unforeseen reactions or malfunctions of the entire system may jeopardise the safety of people or the machine.

- Ensure that the device is equipped with the correct software and that the wiring and settings on the hardware are appropriate.



**WARNING! Danger as a result of unprotected moving components.**

Unforeseen dangers may occur from the entire system when putting the device into operation and maintaining it.

- Switch the entire system off before carrying out any work and prevent it from unintentionally switching back on.
- Before putting the device into operation, ensure that the entire system and parts of the system are safe.
- The device should never be connected or separated under load or voltage.



**CAUTION! Risk of burns from the housing.**

The temperature of the device housing may be elevated.

- Do not touch the housing and let all system components cool before working on the system.

### PROPER USE

The device is used to control or switch one or more electrical systems or sub-systems in motor vehicles and machines and may only be used for this purpose. The device may only be used in an industrial setting.



**WARNING! Danger caused by incorrect use.**

The device is only intended for use in motor vehicles and machines.

- Use in safety-related system parts for personal protection is not permitted.
- Do not use the device in areas where there is a risk of explosion.

**Correct use:**

- operating the device within the operating areas specified and approved in the associated data sheet.
- strict compliance with these instructions and no other actions which may jeopardise the safety of individuals or the functionality of the device.

**Obligations of the manufacturer of entire systems**

It is necessary to ensure that only functional devices are used. If devices fail or malfunction, they must be replaced immediately.

System developments, installation and the putting into operation of electrical systems may only be carried out by trained and experienced staff who are sufficiently familiar with the handling of the components used and the entire system.

It is necessary to ensure that the wiring and programming of the device does not lead to safety-related malfunctions of the entire system in the event of a failure or a malfunction. System behaviour of this type can lead to a danger to life or high levels of material damage.

The manufacturer of the entire system is responsible for the correct connection of the entire periphery (e.g. cable cross sections, correct selection/connection of sensors/actuators).

Opening the device, making changes to the device and carrying out repairs are all prohibited. Changes or repairs made to the cabling can lead to dangerous malfunctions. Repairs may only be carried out by MRS.

**Installation**

The installation location must be selected so the device is exposed to as low a mechanical and thermal load as possible. The device may not be exposed to any chemical loads.

Install the device in such a manner that the plugs point downwards. This means condensation can flow off the device. Single seals on the cables/leads must be used to ensure that no water gets into the device.

**Putting into operation**

The device may only be put into operation by qualified staff. This may only occur when the status of the entire system corresponds to the applicable guidelines and regulations.

### FAULT CORRECTION AND MAINTENANCE



**NOTE The device is maintenance-free and may not be opened.**

- If the device has damage to the housing, latches, seals or flat plugs, it must be taken out of operation.

Fault correction and cleaning work may only be carried out with the power turned off. Remove the device to correct faults and to clean it.

Check the integrity of the housing and all flat plugs, connections and pins for mechanical damage, damage caused by overheating, insulation damage and corrosion. In the event of faulty switching, check the software, switches and settings.

Do not clean the device with high pressure cleaners or steam jets. Do not use aggressive solvents or abrasive substances.